



Diesel Generator Set

mtu 12V4000 DS1750

380V – 11 kV/50 Hz/standby power/NEA (ORDE) optimized
12V4000G74F/water charge air cooling



Optional equipment and finishing shown. Standard may vary.

Product highlights

Benefits

- Low fuel consumption
- Optimized system integration ability
- High reliability
- High availability of power
- Long maintenance intervals

Support

- Global product support offered

Standards

- Engine-generator set is designed and manufactured in facilities certified to standards ISO 2008:9001 and ISO 2004:14001
- Generator set complies to ISO 8528
- Generator meets NEMA MG1, BS 5000, ISO, DIN EN and IEC standards
- NFPA 110

Power rating

- System ratings: 1720 kVA - 1880 kVA
- Accepts rated load in one step per NFPA 110*
- Generator set complies to G3 according to ISO 8528-5
- Generator set exceeds load steps according to ISO 8528-5*

Performance assurance certification (PAC)

- Engine-generator set tested to ISO 8528-5 for transient response
- 85% load factor
- Verified product design, quality and performance integrity
- All engine systems are prototype and factory tested

Complete range of accessories available

- Control panel
- Power panel
- Circuit breaker/power distribution
- Fuel system
- Fuel connections with shut-off valve mounted to base frame
- Starting/charging system
- Exhaust system
- Mechanical and electrical driven radiators
- Medium and oversized voltage alternators

Emissions

- NEA (ORDE) optimized

Certifications

- CE certification option
- Unit certificate acc. to VDE-AR-N 4110

* Changes to the standard parameter sets (alternator-regulator and genset-controller) are necessary



A Rolls-Royce
solution

Application data ¹⁾

Engine

Manufacturer	mtu
Model	12V4000G74F
Type	4-cycle
Arrangement	12V
Displacement: l	57.2
Bore: mm	170
Stroke: mm	210
Compression ratio	16.4
Rated speed: rpm	1500
Engine governor	ECU 9
Max power: kWm	1575
Air cleaner	dry

Fuel system

Maximum fuel lift: m	5
Total fuel flow: l/min	16

Fuel consumption ²⁾

	l/hr	g/kwh
At 100% of power rating:	377.6	199
At 75% of power rating:	288.9	203
At 50% of power rating:	200.2	211

Liquid capacity (lubrication)

Total oil system capacity: l	260
Engine jacket water capacity: l	160
Intercooler coolant capacity: l	40

Combustion air requirements

Combustion air volume: m ³ /s	2.0
Max. air intake restriction: mbar	50

Cooling/radiator system

Coolant flow rate (HT circuit): m ³ /hr	56.0
Coolant flow rate (LT circuit): m ³ /hr	30
Heat rejection to coolant: kW	580
Heat radiated to charge air cooling: kW	310
Heat radiated to ambient: kW	75
Fan power for electr. radiator (40°C): kW	55

Exhaust system

Exhaust gas temp. (after turbocharger): °C	510
Exhaust gas volume: m ³ /s	5.3
Maximum allowable back pressure: mbar	85
Minimum allowable back pressure: mbar	30

Standard and optional features

System ratings (kW/kVA)

Generator model	Voltage	NEA (ORDE) optimized					
		without radiator			with mechanical radiator		
		kWel	kVA*	AMPS	kWel	kVA*	AMPS
Leroy Somer LSA52.3 S5 (Low voltage Leroy Somer standard)	380 V	1504	1880	2856	1440	1800	2735
	400 V	1504	1880	2714	1440	1800	2598
	415 V	1504	1880	2615	1440	1800	2504
Leroy Somer LSA52.3 S6 (Low voltage Leroy Somer oversized)	380 V	1504	1880	2856	1440	1800	2735
	400 V	1504	1880	2714	1440	1800	2598
	415 V	1504	1880	2615	1440	1800	2504
Marathon 743RSL7090 (Low voltage Marathon)	380 V	1472	1840	2796	1432	1790	2720
	400 V	1448	1810	2613	1440	1800	2598
	415 V	1376	1720	2393	1376	1720	2393
Marathon 744RSL7091 (Low voltage Marathon oversized)	380 V	1472	1840	2796	1432	1790	2720
	400 V	1448	1810	2613	1440	1800	2598
	415 V	1376	1720	2393	1376	1720	2393
Marathon 1020FDH7095 (Medium volt. marathon)	11 kV	1488	1860	98	1432	1790	94
Leroy Somer LSA53.2 VL6 (Medium volt. Leroy Somer)	11 kV	1496	1870	98	1440	1800	94

* cos phi = 0.8

1 All data refers only to the engine and is based on ISO standard conditions (25°C and 100m above sea level).

2 Values referenced are in accordance with ISO 3046-1. Conversion calculated with fuel density of 0.83 g/ml. All fuel consumption values refer to rated engine power.

Standard and optional features

Engine

- 4-cycle
- Standard single stage air filter
- Oil drain extension & shut-off valve
- Closed crankcase ventilation
- Governor-electronic isochronous
- Common rail fuel injection
- NEA (ORDE) optimized engine

Generator

- 4 pole three-phase synchronous generator
- Brushless, self-excited, self-regulating, self-ventilated
- Digital voltage regulator
- Anti condensation heater
- Stator winding Y-connected, accessible neutral (brought out)
- Protection IP23
- Insulation class H, utilization acc. to H
- Radio suppression EN 55011, group 1, cl. B
- Short circuit capability 3xIn for 10sec
- Winding and bearing RTDs (without monitoring)
- Excitation by AREP
- Mounting of CT's: 2 core CT's
- Winding pitch: 2/3 winding
- Voltage setpoint adjustment $\pm 10\%$
- Meets NEMA MG-1, BS 5000, IEC 60034-1, VDE 0530, DIN EN 12601, AS 1359 and ISO 8528-3 requirements
- Leroy Somer low voltage generator
- Marathon low voltage generator
- Oversized generator
- Medium voltage generator

Cooling system

- Jacket water pump
- Thermostat(s)
- Water charge air cooling
- Mechanical radiator
- Electrical driven front-end cooler
- Jacket water heater

Control panel

- Unit cabling with coded plugs for easy connection of customer-specific controls (V0)
- Pre-wired control cabinet for easy application of customized controller (V1+)
- Island operation (V2)
- Automatic mains failure operation with ATS (V3a)
- Automatic mains failure operation incl. control of generator and mains breaker (V3b)
- Island parallel operation of multiple gensets (V4)
- Automatic mains failure operation with short (< 10s) mains parallel overlap synchronization (V5)
- Mains parallel operation of a single genset (V6)
- Mains parallel operation of multiple gensets (V7)
- Basler controller
- Deif controller
- Complete system metering
- Digital metering
- Engine parameters
- Generator protection functions
- Engine protection
- SAE J1939 engine ECU communications
- Parametrization software
- Multilingual capability
- Multiple programmable contact inputs
- Multiple contact outputs
- Event recording
- IP 54 front panel rating with integrated gasket
- Different expansion modules
- Remote annunciator
- Daytank control
- Generator winding temperature monitoring
- Generator bearing temperature monitoring
- Modbus TCP-IP

Connectivity

The engine system automatically collects and transfers engine data to the manufacturer from time to time. The data is used by the manufacturer for the purposes of product

development and improvement as well as service optimization. Users can log in or register via <https://mtu-go.com> and also gain insight into the data.

- Represents standard features
- Represents optional features

Standard and optional features

Power panel

- Supply electrical driven radiator from 45kW – 75kW

Circuit breaker/power distribution

- 3-pole circuit breaker
- 4-pole circuit breaker
- Electrical-actuated circuit breaker
- Base frame mounted GCB, pre-wired with generator, ready for commissioning

Fuel system

- Flexible fuel connectors mounted to base frame
- Fuel filter with water separator
- Fuel filter with water separator heavy-duty
- Switchable fuel filter with water separator
- Switchable fuel filter with water separator heavy-duty
- Seperate fuel cooler
- Fuel cooler integrated into cooling equipment

Starting/charging system

- 24V starter
- Redundant starting system
- Starter batteries, cables, rack, disconnect switch (lockable)
- Battery charger
- Alternator

Mounting system

- Welded base frame
- Resilient engine and generator mounting
- Modular base frame design
- Base frame mounting on foundation/base plate with using clamping brackets

Exhaust system

- Exhaust bellows with connection flange
- Exhaust silencer with 10 dB(A) sound attenuation
- Exhaust silencer with 30 dB(A) sound attenuation
- Exhaust silencer with 40 dB(A) sound attenuation
- Y-connection-pipe

- Represents standard features
- Represents optional features

Weights and dimensions

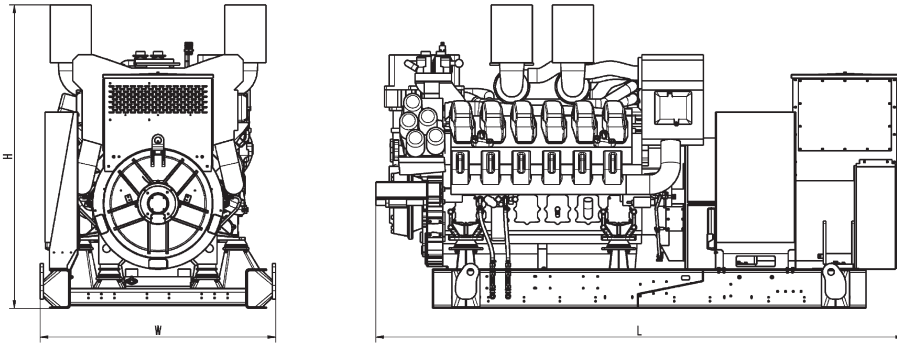

Drawing above for illustration purposes only, based on a standard open power 400 Volt engine-generator set. Lengths may vary with other voltages. Do not use for installation design. See website for unit specific template drawings.

System	Dimensions (LxWxH)	Weight (dry/less tank)
Open power unit (OPU)	4059 x 1810 x 2330 mm	10654 kg

Weights and dimensions are based on open power units and are estimates only. Consult the factory for accurate weights and dimensions for your specific engine-generator set.

Sound data

– Consult your local **mtu** distributor for sound data.

Emissions data

– Consult your local **mtu** distributor for emissions data.

Rating definitions and conditions

- Standby ratings apply to installations served by a reliable utility source. The standby rating is applicable to varying loads for the duration of a power outage. No overload capability for this rating. Ratings are in accordance with ISO 8528-1, ISO-3046-1, BS 5514 and AS 2789. Average load factor: $\leq 85\%$. Operating hours/year: max. 500.
- Consult your local **mtu** distributor for derating information.